



RIGOL

DSG5000 Series

Microwave Signal Generator

Quick Guide

Jun.2022



Guaranty and Declaration

Copyright

© 2022 RIGOL TECHNOLOGIES CO., LTD. All Rights Reserved.

Trademark Information

RIGOL® is the trademark of RIGOL TECHNOLOGIES CO., LTD.

Software Version

Software upgrade might change or add product features. Please acquire the latest version of the manual from **RIGOL** website or contact **RIGOL** to upgrade the software.

Notices

- RIGOL products are covered by P.R.C. and foreign patents, issued and pending.
- RIGOL reserves the right to modify or change parts of or all the specifications and pricing policies at the company's sole decision.
- Information in this publication replaces all previously released materials.
- Information in this publication is subject to change without notice.
- RIGOL shall not be liable for either incidental or consequential losses in connection with the furnishing, use, or performance of this manual, as well as any information contained.
- Any part of this document is forbidden to be copied, photocopied, or rearranged without prior written approval of RIGOL.

Product Certification

RIGOL guarantees that this product conforms to the national and industrial standards in China as well as the ISO9001:2015 standard and the ISO14001:2015 standard. Other international standard conformance certifications are in progress.

Contact Us

If you have any problem or requirement when using our products or this manual, please contact RIGOL.

E-mail: service@rigol.com

Website: <http://www.rigol.com>

1 Safety Requirement

1.1 General Safety Summary

Please review the following safety precautions carefully before putting the instrument into operation so as to avoid any personal injury or damage to the instrument and any product connected to it. To prevent potential hazards, please follow the instructions specified in this manual to use the instrument properly.

- | | | | |
|---|--------------------------------------------------------------------------------------------------------------------------------|----|--------------------------------------------------------|
| 1 | Only the exclusive power cord designed for the instrument and authorized for use within the destination country could be used. | 9 | Do not operate the instrument with suspected failures. |
| 2 | Ensure that the instrument is safely grounded. | 10 | Provide adequate ventilation. |
| 3 | Observe all terminal ratings. | 11 | Do not operate in wet conditions. |
| 4 | Use proper overvoltage protection. | 12 | Do not operate in an explosive atmosphere. |
| 5 | Do not operate without covers. | 13 | Keep instrument surfaces clean and dry. |
| 6 | Do not insert objects into the air outlet. | 14 | Prevent electrostatic impact. |
| 7 | Use the proper fuse. | 15 | Handle with caution. |
| 8 | Avoid circuit or wire exposure. | | |



WARNING

Equipment meeting Class A requirements may not offer adequate protection to broadcast services within residential environment.

1.2 Safety Notices and Symbols

Safety Notices in this Manual:



WARNING

Indicates a potentially hazardous situation or practice which, if not avoided, will result in serious injury or death.



CAUTION

Indicates a potentially hazardous situation or practice which, if not avoided, could result in damage to the product or loss of important data.

Safety Symbols on the Product:

- **DANGER**

It calls attention to an operation, if not correctly performed, could result in injury or hazard immediately.

- **WARNING**

It calls attention to an operation, if not correctly performed, could result in potential injury or hazard.

- **CAUTION**

It calls attention to an operation, if not correctly performed, could result in damage to the product or other devices connected to the product.

Safety Symbols on the Product:

Hazardous Voltage



Safety Warning



Protective Earth Terminal

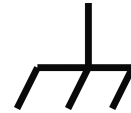

Chassis Ground



Test Ground

1.3 Measurement Category

Measurement Category

This instrument can make measurements in Measurement Category I.

**WARNING**

This instrument can only be used for measurements within its specified measurement categories.

Measurement Category Definitions

- **Measurement category I** is for measurements performed on circuits not directly connected to MAINS. Examples are measurements on circuits not derived from MAINS, and specially protected (internal) MAINS derived circuits. In the latter case, transient stresses are variable. Thus, you must know the transient withstand capability of the equipment.
- **Measurement category II** is for measurements performed on circuits directly connected to low voltage installation. Examples are measurements on household appliances, portable tools and similar equipment.
- **Measurement category III** is for measurements performed in the building installation. Examples are measurements on distribution boards, circuit-breakers, wiring (including cables, bus-bars, junction boxes, switches and socket-outlets) in the fixed installation, and equipment for industrial use and some other

equipment. For example, stationary motors with permanent connection to a fixed installation.

- **Measurement category IV** is for measurements performed at the source of a low-voltage installation. Examples are electricity meters and measurements on primary overcurrent protection devices and ripple control units.

1.4 Care and Cleaning

Care

Do not store or leave the instrument where it may be exposed to direct sunlight for long periods of time.

Cleaning

Clean the instrument regularly according to its operating conditions.

1. Disconnect the instrument from all power sources.
2. Clean the external surfaces of the instrument with a soft cloth dampened with mild detergent or water. Avoid having any water or other objects into the chassis via the heat dissipation hole. When cleaning the LCD, take care to avoid scarifying it.

CAUTION

To avoid damage to the instrument, do not expose it to caustic liquids.



WARNING

To avoid short-circuit resulting from moisture or personal injuries, ensure that the instrument is completely dry before connecting it to the power supply.



1.5 Environmental Considerations

The following symbol indicates that this product complies with the WEEE Directive 2002/96/EC.



The equipment may contain substances that could be harmful to the environment or human health. To avoid the release of such substances into the environment and avoid harm to human health, we recommend you to recycle this product appropriately to ensure that most materials are reused or recycled properly. Please contact your local authorities for disposal or recycling information.

You can click on the following link <https://int.rigol.com/services/services/declaration> to download the latest version of the RoHS&WEEE certification file.

2 Document Overview

This manual gives you a quick review about the front and rear panel of the DSG5000 series, the user interface, and the basic operation method.



TIP

For the latest version of this manual, download it from the official website of **RIGOL** (<http://www.rigol.com>).

Publication Number

QGG04100-1110

Format Conventions in this Manual

1. Key

The front panel key is denoted by the menu key icon. For example,  indicates the Power key.

2. Menu

The menu item is denoted by the format of "Menu Name (Bold) + Character Shading" in the manual. For example, **Freq** indicates clicking or tapping the "Freq" menu to enter the "Freq" setting configuration menu.

3. Operation Procedures

">" denotes the next step of operation. For example, **Interface** > **LAN** indicates that first clicking/tapping **Interface** and then clicking/taping **LAN**.

4. Connector

The connectors on the front or rear panel are usually denoted by the format of "Connector Name (Bold) + Square Brackets (Bold)". For example, **[RF 50Ω]**.

Content Conventions in this Manual

The DSG5000 series includes the following models. Unless otherwise specified, this manual takes DSG5208 as an example to illustrate how to use the DSG5000 series.

Model	Frequency Range	No. of Channels
DSG5202	9 kHz to 20 GHz	2
DSG5204	9 kHz to 20 GHz	4
DSG5206	9 kHz to 20 GHz	6
DSG5208	9 kHz to 20 GHz	8

Model	Frequency Range	No. of Channels
DSG5122	9 kHz to 12 GHz	2
DSG5124	9 kHz to 12 GHz	4
DSG5126	9 kHz to 12 GHz	6
DSG5128	9 kHz to 12 GHz	8

Manuals of this Product

The manuals of this product mainly include the quick guide, user guide, programming guide, data sheet, and etc. For the latest version of this manual, download it from the official website of RIGOL (<http://www.rigol.com>).

3 Quick Start

3.1 General Inspection

1. Inspect the packaging

If the packaging has been damaged, do not dispose the damaged packaging or cushioning materials until the shipment has been checked for completeness and has passed both electrical and mechanical tests.

The consigner or carrier shall be liable for the damage to the instrument resulting from shipment. RIGOL would not be responsible for free maintenance/rework or replacement of the instrument.

2. Inspect the instrument

In case of any mechanical damage, missing parts, or failure in passing the electrical and mechanical tests, contact your RIGOL sales representative.

3. Check the accessories

Please check the accessories according to the packing lists. If the accessories are damaged or incomplete, please contact your RIGOL sales representative.

Recommended Calibration Interval

RIGOL suggests that the instrument should be calibrated every 18 months.

3.2 Appearance and Dimensions

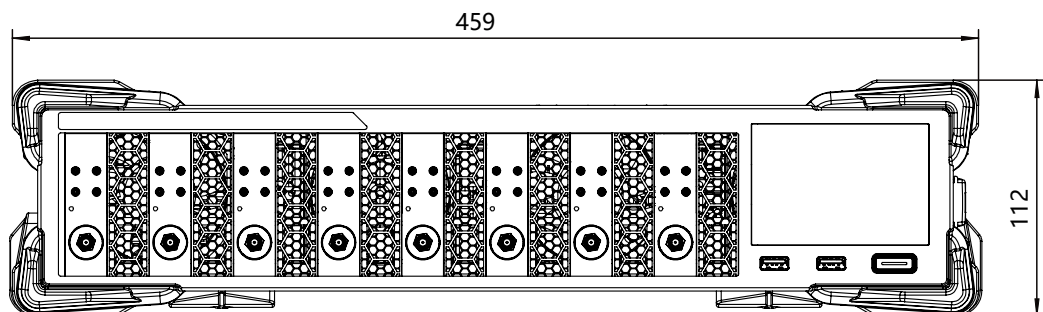

Figure 3.1 Front View (Unit: mm)

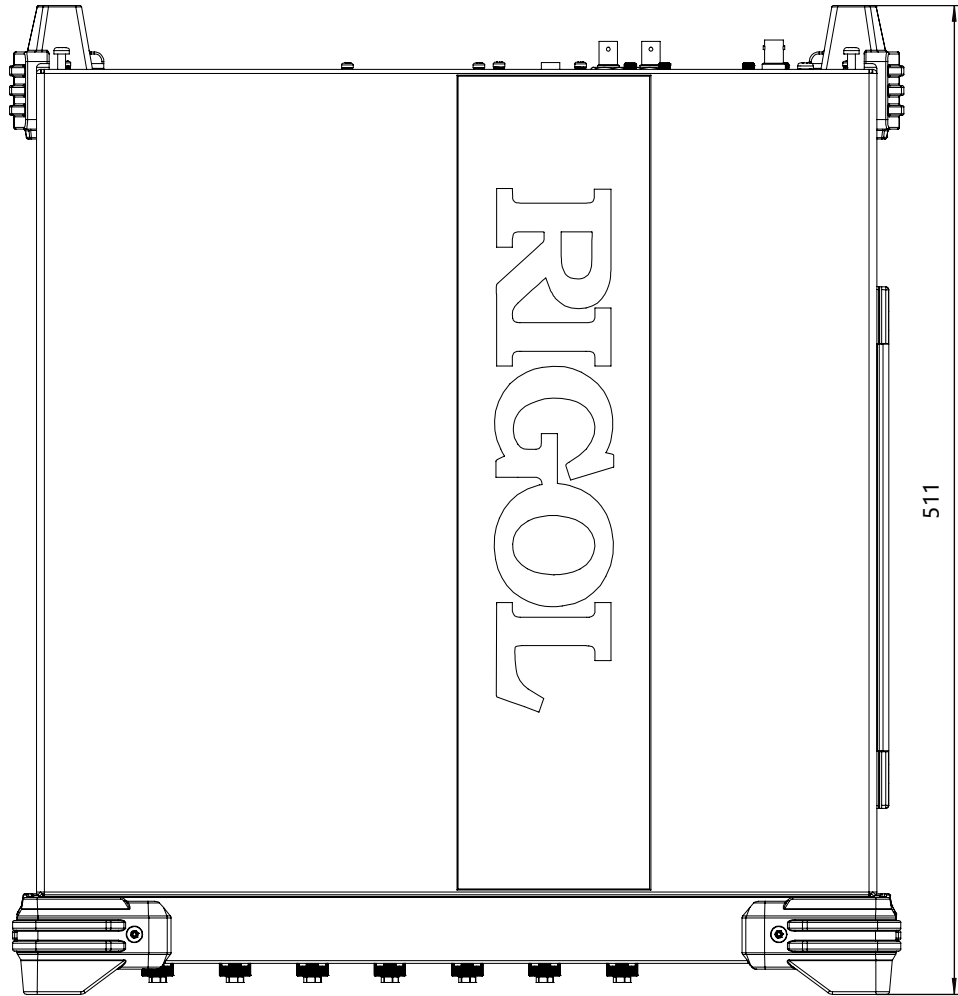

Figure 3.2 Vertical View (Unit: mm)

3.3 Front Panel Overview

The front panel of DSG5000 series microwave signal generator is as shown in *Figure 3.3*.

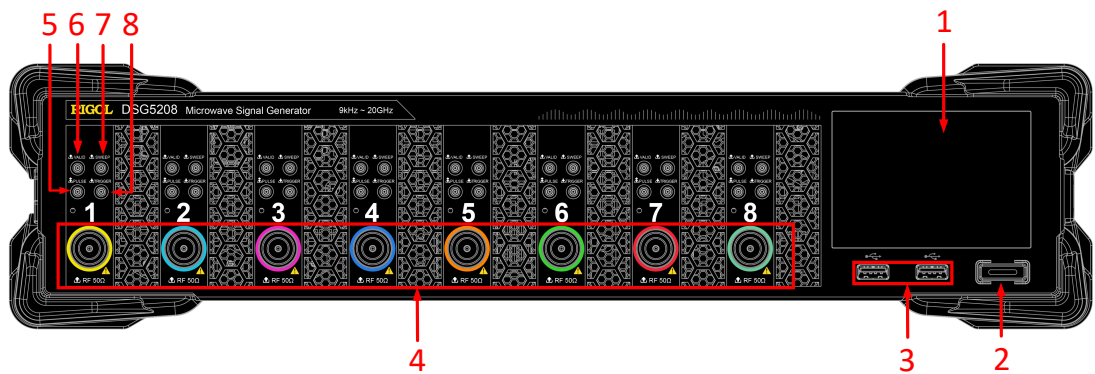



Figure 3.3 DSG5208 Front Panel

1. Touch Screen

Displays the menu label and parameter settings of the current function, system state, prompt messages, and other information.

2. Power Key

Turns on or off the instrument. When this key is turned off, the signal generator is in standby state, indicated by a pulsing LED. To fully remove power from the instrument, turn off the rear panel power switch and remove the power cord.

Click or tap  > **Setting** > **Power Status** to select "Default" or "Open". When "Default" is selected, once the instrument is connected to power source, you need to press the power key button after turning on the rear-panel power switch. When "Open" is selected, once the instrument is connected to power source, the instrument starts automatically after the rear-panel power switch is turned on.

3. USB HOST

This interface is used to connect the USB storage device to upgrade the system, store system states and sweep lists.

4. RF Output Connector

When RF output is enabled, this connector is used to output RF signal and RF sweep signal of the specified channel.

When RF output is enabled and the modulation output is enabled, this connector is used to output the RF modulated signal.

CAUTION

To avoid damage to the instrument, the reverse DC voltage on the RF output connector cannot exceed 0 V, the reverse power must be less than 0.5 W.

5. PULSE Signal Input/Output Connector

The function of this connector is determined by the current working mode of the pulse modulation.

- When the modulation source of the pulse modulation is "Ext", the connector is used to input the external pulse signal.
- When the modulation source of the pulse modulation is "Int" and the pulse switch is ON, the connector is used to output the pulse signal generated by the internal generator. The output signal is related to the "Mode" of the modulation. The mode can be set to "Single" or "Train".

6. VALID Signal Output Connector

When the RF output frequency or amplitude is modified, the internal circuit responded it and processed it, then the instrument outputs the RF signal with the specified frequency and amplitude via the front-panel **[RF 50Ω]** output connector. During this process, the **[VALID]** connector outputs a pulse sync signal, indicating that the RF output signal is valid.

- **High Level**(+3.3 V): indicates that the RF signal is in configuration;
- **Low Level**(0 V): indicates that the RF signal is stable (namely, the signal is valid).

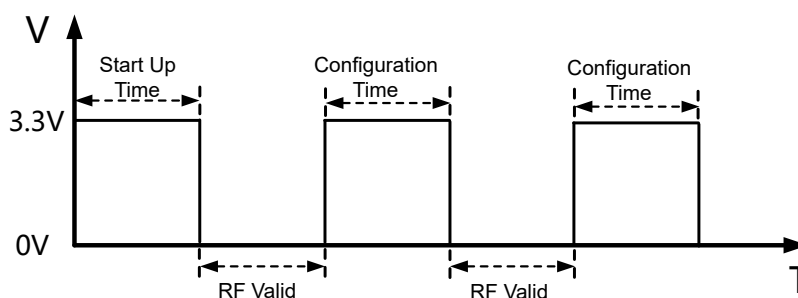

7. SWEEP Output Connector

When the RF sweep function is enabled, the **[SWEEP]** connector outputs a signal (0 V to +10 V) while the front-panel **[RF 50Ω]** output connector outputs the sweep signal according to the current setting. Each sweep corresponds to an output cycle.

- When the sweep type is Step, this output signal is related to the choice of sweep shape which can be set to "Triangle" or "Ramp".
- When the sweep type is List, the default of this output signal is Ramp.

8. External Trigger Input Connector

This connector is used to input the external trigger signal.

- When the trigger type of the sweep is "Ext", this connector is used to input external trigger signal. You can click or tap **Trig Slope** to select "Pos" or "Neg" as the polarity of the trigger signal.
- When the modulation source of the pulse modulation is "Int" and the trigger mode is "Ext", the connector is used to input the external trigger signal.
- When the modulation source of the pulse modulation is "Ext" and the trigger mode is "Gate", the connector is used to input external gate signal.

3.4 Rear Panel Overview

The rear panel of DSG5000 series microwave signal generator is as shown in [Figure 3.4](#).

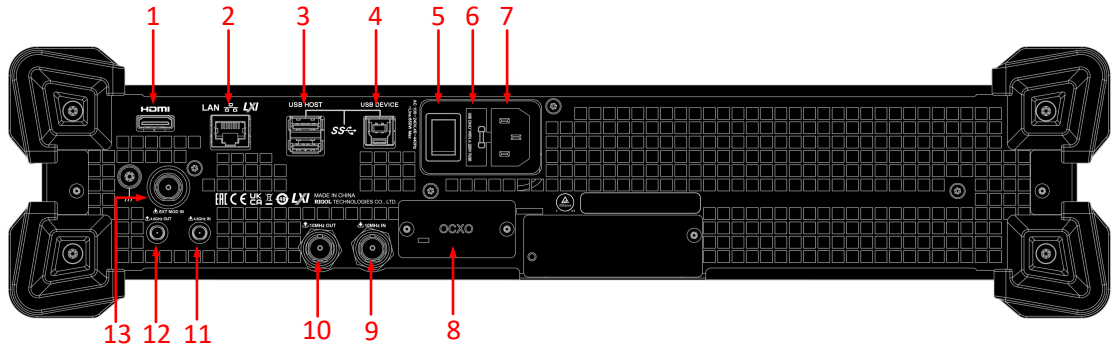

Figure 3.4 DSG5208 Rear Panel

1. HDMI

You can connect the instrument to an external display (e.g. monitor or projector) via this interface to better observe the waveform display clearly.

2. LAN

The instrument is in compliance with the standards specified in LXI Device Specification 2011. It supports to control the instrument through WebServer, Socket, and other modes of remote control. This interface is used to connect the instrument to the PC or network for remote control over the instrument.

3. USB HOST

This interface is used to connect the USB storage device to update the system, store system states and sweep lists.

4. USB DEVICE

This instrument complies with the USBTMC protocol. This interface is used to connect the instrument to the PC for remote control over the instrument.

5. Power Switch

Turns on or off the instrument.

6. Fuse

The fuse rating supported by the instrument is AC 250 V, T3.15A. For fuse replacement, refer to [Fuse Replacement](#).

7. Power Cord Connector

Used to connect the power cord. The AC power specifications of the instrument is as follows: 100 Vac to 240 Vac, 45 Hz to 440 Hz. The power consumption of the instrument cannot exceed 650W (with all the options working). When the signal generator is connected to the AC power source via the power cord, the instrument automatically adjusts itself to within the proper voltage range, and you do not need to select the voltage range manually.

8. OCXO (Option OCXO-D08)

OCXO (Oven Controlled Crystal Oscillator) can provide a highly stable frequency reference over temperature variations.



TIP

A 40-minute warm-up is required for OCXO to reach its nominal frequency.

9. 10 MHz IN

Reference signal input connector. It is used to input the external 10 MHz reference clock signal which is used to synchronize the generator with other instruments.

10. 10 MHz OUT

Reference signal output connector. It is used to output the internal 10 MHz reference clock signal which is used to synchronize the generator with other instruments.

11. 4.8 GHz IN

4.8 GHz input connector. It is used to input the external 4.8 GHz reference clock signal.

12. 4.8 GHz OUT

4.8 GHz output connector. It is used to output the internal 4.8 GHz reference clock signal.

13. EXT MOD IN

External modulation input connector. When the modulation source of AM, FM, or PM is "Ext", this connector is used to input the external modulation signal.

3.5 To Use DSG5000 for the First Time

3.5.1 To Connect to AC Power

Please use the power cord provided in the accessories to connect the signal generator to the AC power source, as shown in *Figure 3.5*. The AC power supply specification of this device is 100-240 Vac, 45-440 Hz. The power consumption of the instrument cannot exceed 650W (with all the options working). When the signal generator is

connected to the AC power source via the power cord, the instrument automatically adjusts itself to within the proper voltage range, and you do not need to select the voltage range manually.

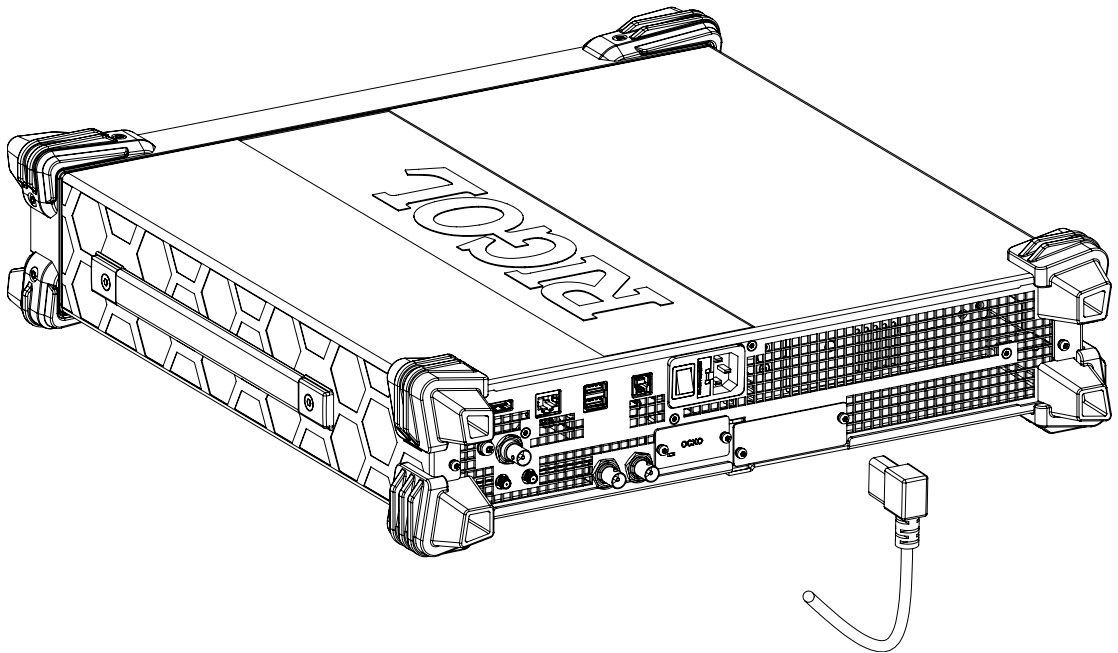

Figure 3.5 To Connect to AC Power



CAUTION

To avoid electric shock, ensure that the instrument is correctly grounded.

3.5.2 Instrument Control

DSG5000 series microwave signal generator has no physical keys to operate except the power key. You can operate on the instrument with the following methods: tap the touch screen to operate; use the externally connected display; Web Control.

- **Touch screen**

The instrument is equipped with a touch screen. You can operate the instrument with the touch screen.

- **Externally connected display**

You can connect the instrument to an external display (e.g. LCD, TV, projector, etc.) via the rear-panel HDMI interface to view the user interface and make parameter settings. To operate on the instrument, connect a USB mouse to the externally connected display via the USB Host interface.

- **Web Control**

Connect the oscilloscope to the network, then input the IP address of the oscilloscope into the address bar of the browser of your computer. The RIGOL web control interface is displayed. Click Web Control to enter the web control page. Then you can view the display of the real-time interface of oscilloscope. Through the Web Control, you can migrate the device control and waveform analysis to the control terminals (e.g. PC, Mobile, iPad, and other smart terminals) to realize remote control of instruments. For methods on how to realize Web Control for the instrument, refer to "*Remote Control*".

**NOTE**

This manual describes how to operate on the touch screen to demonstrate the main functions of the instrument. For some functions that are not accessible through the operation of the touch screen, see detailed descriptions for the relevant functions.

3.5.3 Turn-on Checkout

After connecting the instrument to the power source properly, press the rear-panel power switch key and the power key on the front panel to start the signal generator. During the start-up, the instrument will undergo the initialization and self-check process. Then, it will enter a default interface.

3.5.4 To Set the System Language

The instrument supports multiple system languages. You can click or tap  > **Setting** > **Language** to switch the system language.

3.6 Fuse Replacement

If you need to replace the fuse, use only the specified fuse and perform the following operations:

1. Turn off the instrument, cut off the power, and remove the power cord.
2. Use a small straight slotted screwdriver to pry out the fuse holder.
3. Take out the fuse holder.
4. Replace the old fuse with a specified fuse (AC 250 V, T3.15 A).
5. Install the fuse holder.

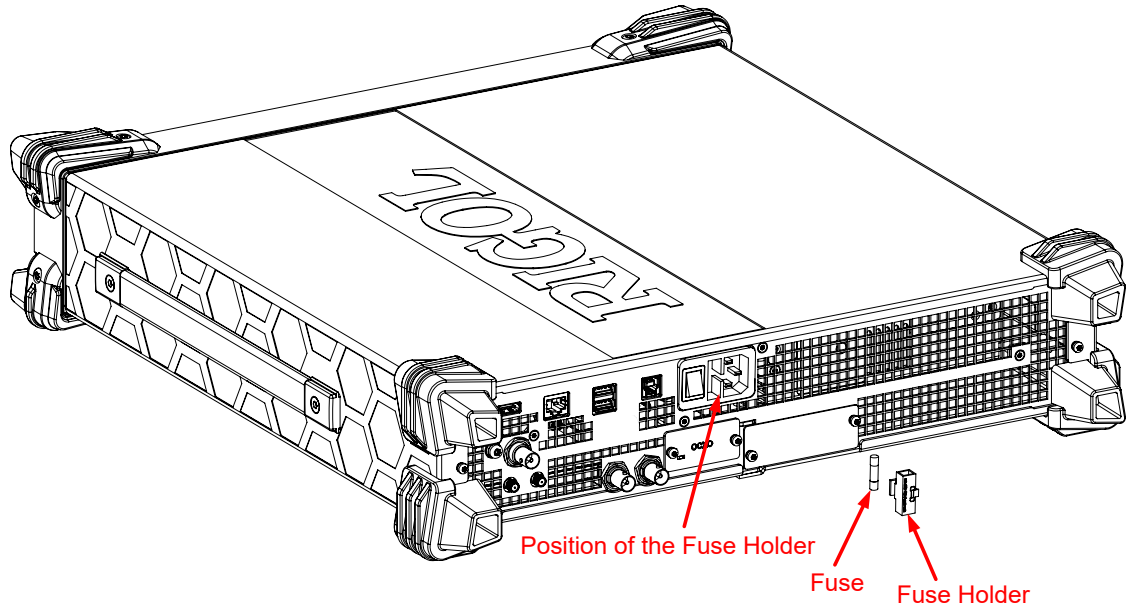

Figure 3.6 Fuse Replacement



WARNING

To avoid electric shock, please ensure that the instrument has been turned off, the power source has been cut off, and the fuse to be used conforms to the fuse rating.

3.7 User Interface

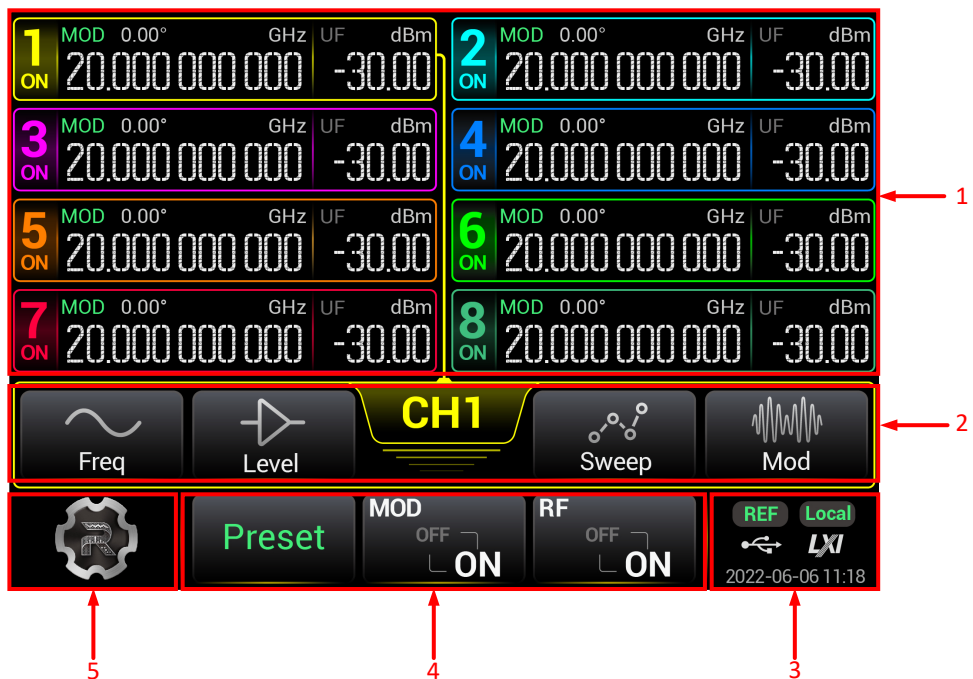

Figure 3.7 User Interface

1. RF Channel Display Area

- Displays the frequency, level, phase, modulation state, RF output state of each channel. It also shows which channel is selected.
- Each channel is indicated in different numbers and colors. The color of the channel is consistent with that of the RF output connector. The "ON" or "OFF" state under the channel No. indicates the RF output status of the specified channel. For each channel displayed in the main interface, the left section is its frequency display area, and the right section is its level display area.
- Click or tap a certain channel to select it. The menu items of the selected channel are enclosed by a check box whose color is the same as the that of channel. For example, when CH1 is selected, the check box for enclosing the parameters of CH1, the connecting line that connect the Channel No. and the channel parameters, the channel No., and the channel color are all indicated in yellow.
- Long press the specified channel area, the channel will be enabled or disabled. When enabled/disabled, the RF out of the channel will be enabled/disabled accordingly.
- MOD status indicates whether the modulation output is enabled for the specified channel. When the modulation output is enabled, if the RF output is enabled for the specified channel, "MOD" is illuminated. **MOD** is displayed in the channel display area. When the modulation output is disabled, "MOD" is in gray and **MOD** is displayed in the channel display area.
- For a device with a different number of channels, the displayed contents and layout of the main interface are different. For example, for the device with 2, 4, or 6 channels, you can see their Offset, Sweep, AM, FM, PM, and Pulse on/off status in the main interface. However, for the device with 8 channels, these information may not be fully displayed.

**NOTE**

The models with 2, 4, or 6 channels include DSG5202, DSG5122, DSG5204, DSG5124, DSG5206, and DSG5126.

2. RF Channel Setting Menu

Sets the parameters for the selected RF channel.

- **CH1:** indicates the currently selected channel.

When you select other channels, it displays the specified channel. The displayed color is the same as that of the channel.

Click or tap it to view more parameter information about this channel. Click or tap it again to close the single-channel information display.

- **Freq:** sets the frequency parameters.

Click or tap **Freq** to enter the frequency parameter setting interface. You can set the parameters such as frequency, frequency offset, and phase offset.

- **Level:** sets the level parameters.

Click or tap **Level** to enter the level parameter setting interface. You can set the parameters such as Level, Limit, Offset, and Flatness. You can also set the level unit.

- **Sweep:** sets the sweep parameters.

Click or tap **Sweep** to enter the signal sweep parameter setting interface. You can set the parameters such as sweep type, sweep mode, and others.

- **Mod:** sets the modulation parameters.

Click or tap **Mod** to enter the signal modulation parameter setting interface. You can select different modulation types and set the modulation parameters.

3. Status Display Area

Displays the system status, including the remote control status, LXI, date and time, etc.

- **Date:** displays the system date and time.
- **LXI:** indicates the LXI certification icon.
- **REF:** When the external 10 MHz reference clock (10 MHz Out connector) is used, REF is displayed.
- **USB storage device icon:** When a USB storage device is detected,  will be displayed.

- **Operation Mode:** **Rmt** indicates that the instrument is operating in remote control mode. **Local** indicates that the instrument is operating in local mode.

4. Global Parameter Setting Area

The parameter settings in this area are global to all the channels or the whole system function.

- **Preset:** Performs the preset operation for the system to restore the system to its default settings or user defined settings.
- **MOD:** Enables or disables the modulation output for all the channels.
- **RF:** Enables or disables the RF signal output for all the channels. As long as the RF output of any one channel is enabled, the RF status shows ON. If the RF output of all the channels are disabled, the RF status shows OFF.



NOTE

- On the touch screen, tapping **MOD** can only enable or disable the modulation output for all the channels.
- If you need to enable or disable the modulation output for one specified channel or multiple channels, run the specified SCPI command to enable or disable the modulation output for a specified channel; also you can connect the instrument to an external display via the HDMI interface to operate. The operation procedures are as follows: In the external display, select a modulation type to enter the modulation interface. Select one channel and click **MOD** in the parameter setting area to enable or disable the modulation output for the channel. If enabled, **MOD** is displayed in the channel display area. The modulation output for each channel can be set independently in this way.

5. System Setting

Click or tap the system setting icon to enter the system setting interface. You can set the interface (e.g. LAN), perform system upgrade, view the system information, perform file operation, etc.

3.8 To Use the Built-in Help File

The built-in help file provides information about the functions and menu introductions of the instrument. You can view the help information for any function or menu during the instrument operation.

Click or tap  > **Help**. The help file is displayed. You can get its help information by clicking on the link for the introduction of the specified function.



4 Application Examples

This chapter introduces the basic operations of the instrument as well as a few specific examples so that the user can quickly master how to operate the signal generator.

4.1 To Output the RF Signal

Output the RF signal with 5 GHz frequency and -10 dBm amplitude from the [RF 50Ω] connector of CH2.

1. Restore to factory setting

Click or tap  > **Preset**. Select the preset type to "Factory". Then click or tap  to go to the main interface. Click or tap **Preset** to restore the instrument to factory defaults. By default, the frequency offset is 0 Hz to and the amplitude offset is 0 dB.



2. Select the channel

Click or tap to select CH2. The main interface shows that CH2 is currently selected.

3. Set the frequency

Click or tap **Freq** > **Freq**. Input the frequency value 5 with the pop-up numeric keypad, and select the unit "GHz".

- The frequency units available are GHz, MHz, kHz, and Hz.
- You can also directly click or tap **Enter** to confirm the default unit for the frequency.
- You can click or tap the input field of the Freq parameter to modify the value.

After completing the frequency setting, click or tap  or  to go to the main interface.

4. Set the amplitude

Click or tap **Level** > **Level**. Input the amplitude value -10 with the pop-up numeric keypad and select the unit "dBm". You can also directly click or tap **Enter** to confirm the default unit dBm.

- The amplitude units available are dBm, V, mV, and uV.
- You can click or tap the input field of the Level parameter to modify the value.



5. Enable the RF output

Long click or tap channel display area of CH2 to enable the RF output of CH2. At this time, the **[RF 50Ω]** connector of CH2 outputs the RF signal based on the current setting. You can also click or tap **RF** to select "ON" to enable the RF output for all the channels.

4.2 To Output the RF Sweep Signal

Configure a continuous linear step sweep to output the RF sweep signal from the **[RF 50Ω]** connector of CH1 to make its frequency stay within a range from 1 GHz to 2 GHz, amplitude from -20 dBm to 0 dBm, the number of sweep points 10, and the dwell time 500 ms.

1. Restore to factory setting

Click or tap  > **Preset**. Select the preset type to "Factory". Then click or tap  to go to the main interface. Click or tap **Preset** to restore the instrument to factory defaults. By default, the frequency offset is 0 Hz and the amplitude offset is 0 dB.

2. Select the channel

Click or tap to select CH1. The main interface shows that CH1 is currently selected.

3. Set the step sweep parameters

Click or tap **Sweep** > **Type** to select "Step".

Click or tap **Setting** > **Freq/Level** to set the frequency and level parameters.

- Start Freq

Click or tap **Start Freq**, then input the start frequency 1 with the pop-up numeric keypad and select the unit "GHz".

- Stop Freq

Click or tap **Stop Freq**, then input the stop frequency 2 with the pop-up numeric keypad and select the unit "GHz".

- Start Level

Click or tap **Start Level**, then input the start level -20 with the pop-up numeric keypad and select the unit "dBm".

- Stop Level

Click or tap **Stop Level**, then input the stop level 0 with the pop-up numeric keypad and select the unit "dBm".

Click or tap  > **Points**, then input the number of sweep points 10 with the pop-up numeric keypad. Click or tap **Enter** to confirm the input.

Click or tap **Dwell Time**, input the value of the dwell time 500 with the pop-up numeric keypad, and then select the unit "ms".

4. Enable RF sweep

Click or tap **Sweep** > **Sweep** to select "Freq & Level" to enable both the frequency sweep and the amplitude sweep.



5. Enable the RF output

Long click or tap channel display area of CH1 to enable the RF output of CH1. At this time, the **[RF 50Ω]** connector of CH1 outputs the RF sweep signal based on the current setting. You can also click or tap **RF** to select "ON" to enable the RF output for all the channels.

4.3 To Output the RF Modulated Signal

Output an AM modulated signal with 800 MHz frequency and -20 dBm amplitude from the **[RF 50Ω]** connector of CH2. Set the AM modulation depth to 60% and the modulation frequency to 20 kHz.

1. Restore to factory setting

Click or tap  > **Preset**. Select the preset type to "Factory". Then click or tap  to go to the main interface. Click or tap **Preset** to restore the instrument to factory defaults. By default, the modulation source is Internal and the modulating waveform is Sine.

2. Select the channel

Click or tap to select CH2. The main interface shows that CH2 is currently selected..

3. Set the carrier frequency and amplitude

a. Carrier frequency

Click or tap **Freq** > **Freq**. Input the frequency value 800 with the pop-up numeric keypad, and select the unit "MHz".

b. Carrier amplitude

Click or tap **Level** > **Level**. Input the amplitude value -20 with the pop-up numeric keypad and select the unit "dBm". You can also directly click or tap **Enter** to confirm the default unit dBm.

4. Set the AM modulation parameters

- a. Click or tap **Mod** > **AM** to enter the AM setting interface.
- b. Click or tap **Depth**. Then input the AM depth value 60 with the pop-up numeric keypad and select the unit "%". You can also directly click or tap **Enter** to confirm the default unit %.
- c. Click or tap **Freq**. Input the modulation frequency value 20 with the pop-up numeric keypad, and select the unit "kHz".
- d. Click or tap **Switch** to select "ON" to enable the AM function.

5. Enable the RF modulation output

Click or tap **MOD** in the main interface to enable the modulation output. Then long click or tap the channel display area of CH2 to enable the RF output of CH2. At this time, the **[RF 50Ω]** connector of CH2 outputs the AM modulated signal based on the current setting.



TIP

Click or tap **MOD** in the interface to select "ON" to enable the modulation output for all the channels. If you only want to enable the modulation output of CH2, connect an external display via the HDMI interface. Then send the specified SCPI command to enable the modulation output of CH2 or operate on the externally connected display.

5 Remote Control

The device can be connected to the PC via the USB or LAN to set up communication and realize remote control through the PC. Three ways of remote control are supported: user-defined programming, PC software, and Web Control.

- **User-defined Programming**

Users can program and control the instrument by using the SCPI (Standard Commands for Programmable Instruments) commands. For details about the SCPI commands and programming, refer to *Programming Guide*.

- **PC Software**

Users can use the PC software to send commands to control the instrument remotely. RIGOL Ultra Sigma is recommended. You can download the software from RIGOL official website (<http://www.rigol.com>).

Operation Procedures:

- Set up communication between the instrument and PC.
- Run Ultra Sigma and search for the instrument resource.
- Open the remote command control panel to send commands.

- **Web Control**

This instrument supports Web Control. Connect the instrument to the network, then input the IP address of the instrument into the address bar of the browser of your computer. The web control interface is displayed. Click Web Control to enter the web control page. Then you can view the display of the real-time interface of the instrument. Through the Web Control, you can migrant the device control to the control terminals (e.g. PC, mobile phone, iPad, and other smart terminals) to realize remote control of the instrument. When you first log in to the Web Control, use the user name "admin" and the password "rigol".



CAUTION

Before setting up communication, please turn off the instrument to avoid causing damage to the communication interfaces.

6 Troubleshooting

This chapter lists the encountered failures of DSG5000 and their solutions. If the following problems occur, locate and resolve the problems according to the following steps. If the problems still persist, contact RIGOL and provide your instrument

information to us. (For instrument information, click or tap  > **System** to obtain the device information.)

When I power on the instrument, the instrument stays black and does not display anything.

1. Check whether the fan is running.
 - If the fan works normally, but the screen stays black, check whether the connecting cable that connects the screen is loose.
 - If the fan does not work normally, it indicates that the instrument has failed to start up. Please handle it according to the method specified in Step 2.
2. Check whether the power supply has been connected correctly and the power switch has been turned on.
3. Check whether the fuse has been burnt. If you need to replace the fuse, please use the specified fuse (AC 250V, T3.15 A).
4. Restart the instrument after finishing the above inspections.
5. If the problem still persists, please contact RIGOL.

The settings are correct, but the waveform is not generated properly.

There is no RF output.

1. Check whether the signal connecting cable is tightly connected to the corresponding **[RF 50Ω]** connector.
2. Check whether the connecting cable has internal damage.
3. Check whether the connecting cable is tightly connected to the test instrument.
4. Check whether corresponding RF channel is enabled and the color of the user interface display area is the same as that of the channel.

5. Check whether the output amplitude of the RF signal is too small. If yes, adjust the output amplitude properly.

The RF output is not modulated.

1. Check whether the signal connecting cable is tightly connected to the corresponding [RF 50Ω] connector.
2. Check whether the connecting cable has internal damage.
3. Check whether the connecting cable is tightly connected to the test instrument.
4. Check whether MOD and RF are both enabled.
5. Check whether the modulation parameter setting is correct and adjust the parameter appropriately.
6. If external modulation source is used, make sure that the external source is correctly connected and outputs signal. At the same time, the external source should work within the specified range of the signal generator.

In list or step sweep, the level does not change.

1. Make sure that the sweep function is set to "Level" or "Freq & Level".
2. If the current sweep function is set to "Freq", the level value will not be changed.

The USB storage device cannot be recognized.

1. Check whether the USB storage device can work normally when connected to other instruments or PC.
2. Make sure that the USB storage device used is a Flash type. This instrument does not support hardware USB storage device.
3. After restarting the instrument, insert the USB storage device again to check whether it works normally.
4. If the USB storage device still cannot work normally, please contact RIGOL.

The performance specifications test is failed.

1. Check whether the instrument is within calibration period (1 year).

2. Check whether the instrument has been warmed up for at least 30 minutes before the test.
3. Check whether instrument is under the specified temperature.
4. Confirm whether the test is under strong-magnetic environment.
5. Check whether the power supplies of the instrument and the test system have a strong interference.
6. Check whether the performance of the test device used meets the requirement.
7. Make sure that the test device used is within the calibration period.
8. Check whether the test devices used meets the required conditions of the manual.
9. Check whether all the connections are tight.
10. Check whether any cable has internal damage.
11. Make sure that the operations conform to settings and processes which are required by the performance verification manual.
12. Check whether the error calculation has faults.
13. Correctly understand the definitions of "Typical", and "Nominal" values for this product.

Typical: typical performance, which 80 percent of the measurement results will meet at room temperature (approximately 25°C). The data are not warranted and do not include the measurement uncertainty.

Nominal: the expected mean or average performance or a designed attribute (such as the 50Ω connector). The data are not warranted and are measured at room temperature (approximately 25°C).

HEADQUARTER

RIGOL TECHNOLOGIES CO., LTD.
No.8 Keling Road, New District, Suzhou,
JiangSu, P.R.China
Tel: +86-400620002
Email: info@rigol.com

EUROPE

RIGOLTECHNOLOGIES EU GmbH
Carl-Benz-Str.11
82205 Gilching
Germany
Tel: +49(0)8105-27292-0
Email: info-europe@rigol.com

NORTH AMERICA

RIGOLTECHNOLOGIES, USA INC.
10220 SW Nimbus Ave.
Suite K-7
Portland, OR 97223
Tel: +1-877-4-**RIGOL**-1
Fax: +1-877-4-**RIGOL**-1
Email: info@rigol.com

JAPAN

RIGOLTECHNOLOGIES JAPAN, LLC
501, LATORRETTA, 2-37-1,
Numabukuro,
Nakano-Ku, Tokyo, Japan
Tel: +81-3-6262-8932
Fax: +81-3-6262-8933
Email: info-japan@rigol.com

RIGOL® is the trademark of **RIGOLTECHNOLOGIES CO., LTD.** Product information in this document subject to update without notice. For the latest information about **RIGOL's** products, applications and services, please contact local **RIGOL** channel partners or access **RIGOL** official website: www.rigol.com